



The Timken Company
4500 Mt Pleasant St. NW
N. Canton, OH 44720
Phone: (234) 262-3000

E-Mail: CustomerCAD@timken.com • Web site: www.timken.com

Part Number 61902-2RZ-C3, Thin Section Ball Bearings (61700, 61800, 61900)

Timken's deep groove ball bearings deliver reliable performance in a wide range of applications and conditions. With super-finished raceways and controlled geometries, our premium design helps ensure consistent quality.

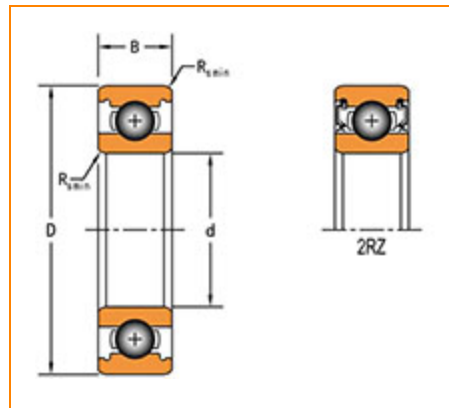

[Specifications](#) | [Dimensions](#) | [Basic Load Ratings](#) | [Factors](#)

Specifications

Clearance	C3
Bore Size d	15.000 mm
Features	Non-Contact Seals
Weight	0.015 Kg

Dimensions

Outside Diameter D	28.000 mm
Outside Ring Width B	7.000 mm
Radius R_s min	0.300 mm



Basic Load Ratings

Cr - Dynamic Load Rating 4.3 kN

C0r - Static Load Rating 2.3 kN

Factors

Grease Limiting Speed 24000 rpm

Oil Limiting Speed 29000 rpm

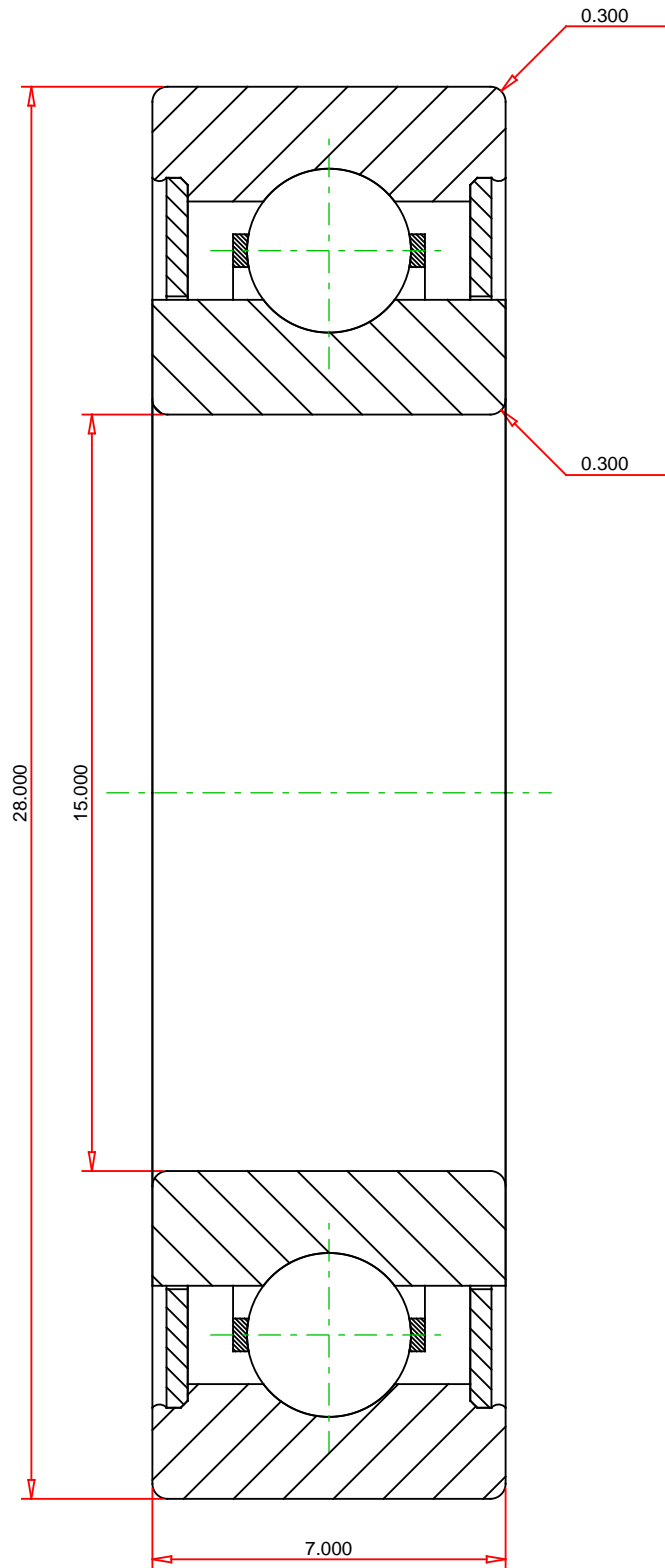

METRIC UNITS

Weight 0.02 kg

TIMKEN®

THE TIMKEN COMPANY
NORTH CANTON, OHIO USA

61902-2RZ-C3
Thin Section Ball Bearings (61700, 61800, 61900)

Dynamic Load Rating 4600 N
Static Load Rating 2000 N

Every reasonable effort has been made to ensure the accuracy of the information contained in this writing, but no liability is accepted for errors, omissions or for any other reason.

FOR DISCUSSION ONLY